



Transcend™ Chair Series

Carry Chair, Manual Tracks, and PowerTraxx®



Read this Manual and Retain  for Future Reference

FERNO®

Users' Manual

June 2022

Pub. No. 234-3801-01

Ferno Customer Relations

For ordering assistance or general information:

CANADA AND THE U.S.A.

Telephone (Toll-free)	1.877.733.0911
Telephone	1.937.382.1451
Fax (Toll-free)	1.888.388.1349
Fax	1.937.382.1191
Internet	www.ferno.com

ALL OTHER LOCATIONS

For assistance or information, please contact your Ferno distributor. If you do not have a Ferno distributor, please contact Ferno Customer Relations:

Ferno-Washington, Inc., 70 Weil Way
Wilmington, Ohio 45177-9371, U.S.A.

Telephone	Country Code +1.937.382.1451
Fax	Country Code +1.937.382.6569
Internet	www.ferno.com

Disclaimer

This manual contains general instructions for the use, operation and care of this chair. The instructions are not all-inclusive. Safe and proper use of this chair is solely at the discretion of the user. Safety information is included as a service to the user. All other safety measures taken by the user should be within and under consideration of applicable regulations and local protocol. Training on the proper use of this chair must be provided before using this chair in an actual situation.

Retain this manual for future reference. Include it with the chair in the event of transfer to new users. Additional free copies are available upon request from Customer Relations.

Proprietary Notice

The information disclosed in this manual is the property of Ferno-Washington, Inc., Wilmington, Ohio, USA. Ferno-Washington, Inc. reserves all intellectual property rights, proprietary design rights, manufacturing rights, rechairion use rights, and sales use rights thereto, and to any article disclosed therein except to the extent those rights are expressly granted to others or where not applicable to vendor proprietary parts.

Limited Warranty Statement

The chairs sold by Ferno are covered by a limited warranty, which is printed on all Ferno invoices. The complete terms and conditions of the limited warranty, and the limitations of liability and disclaimers, are also available upon request by calling Ferno at 1.800.733.3766 or 1.937.382.1451.

Adverse Event Notice

In the event of an adverse event or serious incident related to the use of this device, the end user/operator must report the incident to Ferno-Washington, Inc. at 70 Weil Way, Wilmington, Ohio 45177 USA, 1-877-733-0911, or via email at tscoordinator@ferno.com. If the incident occurred in the European Union, report it to Ferno's Authorized EU Representative and the competent authority of the Member State in which the end user is established.



USERS' MANUALS

To request additional free users' manuals, contact Ferno Customer Relations, your Ferno distributor, or www.ferno.com.



FERNO Product Name/Model

 Date of Manufacture		(01) Global Trade Item Number
 Serial Number		(11) Date of Manufacture
		(21) Serial Number

 Ferno-Washington Inc. | Wilmington, Ohio 45177 USA | +1.937.382.1451
↑ Manufacturer ↑ GS1 Data Matrix

Unique Device Identification (UDI)

Ferno complies with the United States Food and Drug Administration's (FDA) Unique Device Identification (UDI) regulation to identify medical devices. The UDI label contains information in human- and machine-readable form. Device information is online at the FDA's Global Unique Device Identification Database (GUDID). The public can search and download information at AccessGUDID at www.fda.gov.

The label is located on the chair frame behind the back panel.



Ferno-Washington, Inc.
70 Weil Way
Wilmington, Ohio 45177-9371, U.S.A.
1.937.382.1451



FERNO S.r.l.
via B. Zallone, 26
40066 Pieve di Cento BO
Italy (+39) 0516860028



Ferno (UK) Ltd.
Ferno House, Stubs Beck Lane
Cleckheaton, West Yorkshire, BD19 4TZ
+44 (0) 1274 851999



TABLE OF CONTENTS

Section	Page	Section	Page
Ferno Customer Relations _____	2	6 - Using the Chair _____	21
Unique Device Identification (UDI) _____	2	6.1 Before Placing the Chair in Service _____	21
1 - Safety Information _____	4	6.2 General Guidelines for Use _____	21
1.1 Warning _____	4	6.3 Folding and Unfolding the Chair _____	22
1.2 Notice _____	4	6.4 Transferring the Patient _____	23
1.3 Tip _____	4	6.5 Rolling the Chair _____	23
1.4 Bloodborne Disease Notice _____	4	6.6 Transporting the Patient Down Stairs _____	24
1.5 Symbol Glossary _____	5	6.7 Transporting the Patient Up Stairs _____	27
1.6 Safety and Instruction Labels _____	6	6.8 Pausing On the Stairs _____	29
1.7 Compliance _____	6	6.9 Using a PowerTraxx Chair Without Power _____	29
2 - Operator Focus _____	7	7 - Maintenance _____	30
2.1 Operator Training _____	7	7.1 Maintenance Schedule _____	30
2.2 Daily Operator Duties _____	7	7.2 Disinfecting/Cleaning Restraints _____	30
2.3 Using Additional Help _____	8	7.3 Disinfecting/Cleaning the Chair _____	30
3 - About the Chair _____	9	7.4 Cleaning Tracks and Belts _____	30
3.1 Description _____	9	7.5 Lubrication-Free Chair and Tracks _____	30
3.2 General Specifications _____	10	7.6 Inspecting the Chair _____	31
3.3 Component: Carry Chair & Manual Track Chair _____	11	7.7 Controller Battery _____	32
3.4 Components: PowerTraxx _____	12	7.8 PowerTraxx Motor Status Lights _____	32
4 - PowerTraxx System _____	13	7.9 Removing and Attaching the Backrest and Seat Panels _____	33
4.1 PowerTraxx Components _____	13	7.10 Interconnect Cord for PowerTraxx _____	34
4.2 Main Battery _____	14	7.11 Storing the Main Battery _____	35
4.3 Attaching and Removing the Main Battery _____	15	7.12 Recycling Notice _____	35
4.4 PowerTraxx Controller _____	15	8 - Initial Setup _____	36
4.5 Scene Lights _____	16	8.1 First-Time Setup _____	36
4.6 Sleep Mode _____	16	8.2 Ankle Restraint _____	36
5 - Features and Options _____	17	8.3 Attaching Patient Restraints _____	37
5.1 Track System (Excludes Carry Chair) _____	17	8.4 Restraint Configurations _____	37
5.2 Lift Bar _____	18	9 - Parts and Service _____	38
5.3 IV Bag Clip _____	18	9.1 U.S.A. and Canada _____	38
5.4 Rear Lift Handles _____	19	9.2 Worldwide _____	38
5.5 Telescoping Lift Handles _____	19	9.3 Parts List _____	38
5.6 Armrests _____	19	10 - Accessories _____	40
5.7 Footrest _____	20	Training Record _____	41
5.8 Wheel Locks _____	20	Maintenance Record _____	42
		Notes _____	43

1 - SAFETY INFORMATION

1.1 Warning

Warning safety alerts indicate a potentially hazardous situation that, if not avoided, could result in injury or death.

	 WARNING
	<p style="text-align: center;">DO NOT OPEN POWER UNIT.</p> <p>No user-serviceable parts inside. Contact Ferno for service.</p>

 WARNING
<p>Untrained helpers can cause injury or be injured. Trained operators must operate the controls and direct helpers where to grasp the chair to avoid pinch points.</p> <p>Improper use of the chair can cause injury. Use the chair only for the purpose described in this manual.</p> <p>Improper charging can cause injury or damage. Use only the Ferno-approved battery with the chair, and charge only with the Ferno-approved battery charger.</p> <p>Modifying the battery can cause injury and damage. Use the battery only as designed by Ferno.</p> <p>Improper maintenance can cause injury and damage. Maintain the chair and battery only as described in this manual.</p> <p>Using the chair with an unlocked track system can cause injury. Verify that the track system is locked before transporting the patient.</p> <p>Lubricating the track system can result in injury to the patient and/or operators. Never lubricate the tracks or belts.</p> <p>Improper operation can cause injury. Operate the chair only as described in this manual.</p> <p>An unattended patient can be injured. Stay with the patient at all times.</p> <p>An unrestrained patient can be injured. Use patient restraints to secure the patient on the chair.</p> <p>Track Chair Models: Using the chair with the track system unlocked can cause injury. Verify that the track system is locked before transporting the patient.</p> <p>Improper maintenance can cause injury. Maintain the chair only as described in this manual.</p> <p>Attaching improper items to the chair can cause injury. Use only Ferno-approved items on the chair.</p> <p>Improper parts and service can cause injury. Use only Ferno parts and Ferno-approved service on the chair.</p> <p>Modifying the chair can cause injury and damage. Use the chair only as designed by Ferno.</p>

1.2 Notice

Notices emphasize important, but not hazard-related information. Failure to follow Notices could result in chair or property damage.

NOTICE

1.3 Tip

Tips provide recommendations for easier use of the chair.









Tip









1.4 Bloodborne Disease Notice

To reduce the risk of exposure to blood or other potentially infectious materials when using the chair, follow the disinfecting and cleaning instructions in this manual.

1.5 Symbol Glossary

The symbols defined here are used on the chair and/or in this' manual. Ferno uses symbols recognized by the International Standards Organization (ISO), American National Standards Institute (ANSI) and the emergency medical services industry.

Symbol	Definition
	General warning of potential injury
	Pinch point: Keep hands clear
	Pinch point (belts): Keep hands clear
	General warning of potential electric shock
	Read the users' manual
	Load capacity (safe working load)
	Read the users' manual (ISO 7000)
	Lock
	Unlock

Symbol	Definition
	Ascend
	Descend
	Do not lubricate
	Battery status
	Wireless connection
	Check temperature
	Check button (ENDURACharge battery)
	Service required (ENDURACharge battery)

1.6 Safety and Instruction Labels

Safety and instruction labels place important information from the users' manual on the chair. Read and follow label instructions. Replace worn or damaged labels immediately.

Symbol	Feature
A	General Warning Label: General injury warning; read the users' manual; two trained operators; chair load capacity.
B	Ratings Label: Product name, general injury warning, read the users' manual, manufacturer.
C	Pinch point. Keep hands clear.
D	Pinch point (belts). Keep hands clear.
E	Do not lubricate (track chair only).

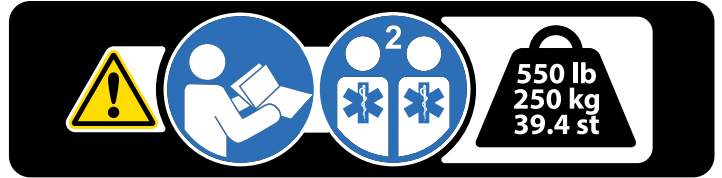

A



B



C



D



E

1.7 Compliance

The chair meets the following standards:

- **Medical Device Regulation (EU)2017/745, Annex 1, Section 23.4 and 21 CFR 801.5** as established by the European Union
- **IEC 60601-1-2:2014:** Electrical and electromagnetic testing
- **IEC 60601-1-12:** Temperature and vibration testing
- **IP56:** Ingress Protection rating. Tested in compliance with dust and water infiltration standards.
- **EN 1865:** Performance and crash-test standards
- **RoHS-2:** Meets the requirements of EU Directive 2011/65/EU and as amended by EU Directive 2015/863 ("RoHS-3") on the restriction of the use of certain hazardous substances.

2 - OPERATOR FOCUS

2.1 Operator Training

Operators using the chair:

- must read and understand this manual.
- must have training on proper use of the chair.
- must have a training on emergency-medical service and emergency patient-handling procedures.
- must have the physical ability to assist the patient.
- must practice with the chair before using it with a patient.
- must keep training records. For a sample training record sheet, see “Training Record” on page 41.

WARNING

Untrained helpers can cause injury or be injured. Trained operators must operate the controls and direct helpers where to grasp the chair to avoid pinch points.



Load Capacity

Inspect the chair if the load capacity has been exceeded. See “Inspecting the Chair” on page 31.

2.2 Daily Operator Duties

It is good practice for operators to check equipment at the start of each work shift. To check the chair prior to use, follow the procedures described in this manual:

- Unfold and fold the chair.
- Open and close the track system (if applicable).
- Roll the chair in a circle to verify it rolls easily.
- Visually inspect the chair for readiness. See “Inspecting the Chair” on page 31.
- PowerTraxx: Verify the battery is charged and all powered controls function properly.



2.3 Using Additional Help

Operating the chair requires a minimum of two trained operators. They may need additional trained help when working with heavy loads (patient plus equipment), or when operating or carrying the chair manually.

- A trained operator stands at each end of the chair facing each other, maintains control of the chair, operates the controls, and direct helpers on where to stand and how to grasp the chair.
- If available, a third trained helper “spots” for the lead operator when descending stairs.
- Ferno recommends that helpers work in pairs to help maintain chair balance.

Refer to the chart for suggested placement for operators and helpers.

Direction	Rolling on Flat Surface
Two Operators and Two Helpers	

Direction	 DESCEND	 ASCEND
Two Operators and One Helper		
Two Operators and Three Helpers		

Key: O = Operator H = Helper S = Spotter P = Patient

3 - ABOUT THE CHAIR

3.1 Description

The Ferno® Transcend Chair (referred to the chair in this manual) is an emergency patient-handling device designed to transport a seated patient up or down stairs and over flat surfaces.

The chair is for professional use by a minimum of two trained operators. A third person to “spot” may be required by local protocols. Additional help may be required when working with heavy patients.

MODELS AVAILABLE

- Transcend carry chair with no tracks
- Transcend manual track chair
- Transcend PowerTraxx® chair (powered tracks)

FEATURES

- 5-position telescoping front lift handle (2)
- Lift bar (fixed or 5-position extending)
- Folding rear lift handles (option)
- Molded seat and back panels
- Folding footrest (option)
- IV bag clip
- 8” rear wheels (with or without locks)
- 5” front swivel wheels
- Patient restraints (3) and ankle restraint (1)

POWERTRAXX FEATURES

- PowerTraxx modular, motorized track system powers the chair up and/or down stairs
-  buttons controls track-belt motion
- Wireless connectivity between the controls and motor
- Scene lights reflective illumination
- Track brake (stops PowerTraxx motion when control buttons are not being pressed)
- Battery Options:
 - Ferno **ENDURACHARGE™** 36V lithium-ion battery
 - Milwaukee® 28V lithium-ion battery
- Compatible with ambulance in-fastener charging systems

ACCESSORIES

- Your chair may have been shipped with factory-installed accessories per your order; accessories are also available separately.

WARNING

Improper use of the chair can cause injury. Use the chair only for the purpose described in this manual.

Model Options	Carry Chair	Track Chair	PowerTraxx Chair
Fixed Lift Bar	•	•	
Extending Lift Bar	•	•	•
Rear Lift Handles	•	•	•
Footrest	•	•	•
Solid Rear Wheels w/ Locks	•	•	•
Tri-Spoke Rear Wheels, No Locks	•	•	
Glide Bar	•	•	•
Armrests	•	•	•
Nylon Patient Restraints	•	•	•

3.2 General Specifications

Specifications are shown in the table below. Ferno reserves the right to change specifications without notice. For more information, contact Ferno Customer Relations or your Ferno distributor (page 2). Ferno reserves the right to change specifications without notice.

Dimensions	Imperial	Metric
Height		
Maximum	60 in	1518 mm
Minimum	36 in	908 mm
Width		
Overall	20 in	505 mm
Seat	16 in	408 mm
Depth (front to back)		
Carry Chair, No Tracks	30 in	760 mm
Tracks closed, Handles retracted	30 in	760 mm
Tracks open, Handles extended	53 in	1346 mm
Folded (Length x Width x Depth)		
All Models	36 x 20 x 7.9 in	912 x 507 x 200 mm
Rear Wheels, Tri-Spoke		
Diameter	7.9 in	200 mm
Width	1.2 in	30 mm
Rear Wheels, Solid		
Diameter	7.7 in	195 mm
Width	1.5 in	40 mm
Front Wheels		
Diameter	5 in	127 mm
Width	1.3 in	32 mm



Load Capacity

Inspect the chair if the load capacity has been exceeded. See "Inspecting the Chair" on page 31.

Specifications	Imperial	Metric
Load Capacity	550 lb	250 kg
Load Capacity (UK)		39.4 st
Weight*, Carry Chair	28 lb	12.7 kg
Weight*, Manual Track Model	32 lb	14.7 kg
Weight**, PowerTraxx Model	51 lb	23.3 kg
Chair Construction	Tubular aluminum	
Seat/Back Panels	Nylon Glass-Filled Plastic	
Wheel Bearings	Sealed/greaseless	
Main Battery	36V or 28V	

*Minimum weight. Weights vary based on installed options.

**Weight includes battery.

3.3 Component: Carry Chair & Manual Track Chair





3.4 Components: PowerTraxx



4 - POWERTRAXX SYSTEM

4.1 PowerTraxx Components

The PowerTraxx (Figures 1 and 2) consists of the following components:

- **CONTROLLER:** The controller attached to the lift bar allows the operator to control the direction of the belts, the scene lights and monitor the battery and wireless connection.
- **CONTROL BUTTONS:** The  and  control buttons are attached to the controller.
- **SCENE LIGHTS (2):** LED lights located on top of the power unit and are controlled by the  button on the controller.
- **CONTROLLER BATTERY:** The battery is inside the controller and provides power to the controller. See "Controller Battery" on page 32.
- **BELT (2):** The belts engage the stairs. The motor powers the belts. The user controls the direction using the control buttons.
- **MAIN BATTERY:** The battery attaches to the power unit and provides power. It is easy to remove, charge, and reattach. See "Main Battery" on page 14.
- **POWER UNIT:** The power unit located between the tracks receives input from the buttons to control the direction of the belts. It also monitors other aspects of the chair.
- **WIRELESS COMMUNICATION:** Wireless connectivity provides communications between the power unit and controller.
- **SPEED LIMITER (part of the power unit):** If the system loses power, the belts are free to rotate for non-powered descent. However, the speed limiter retards the speed of the belts to improve operator control for the descent.

	 WARNING
	<p>DO NOT OPEN POWER UNIT.</p> <p>No user-serviceable parts inside. Contact Ferno for service.</p>

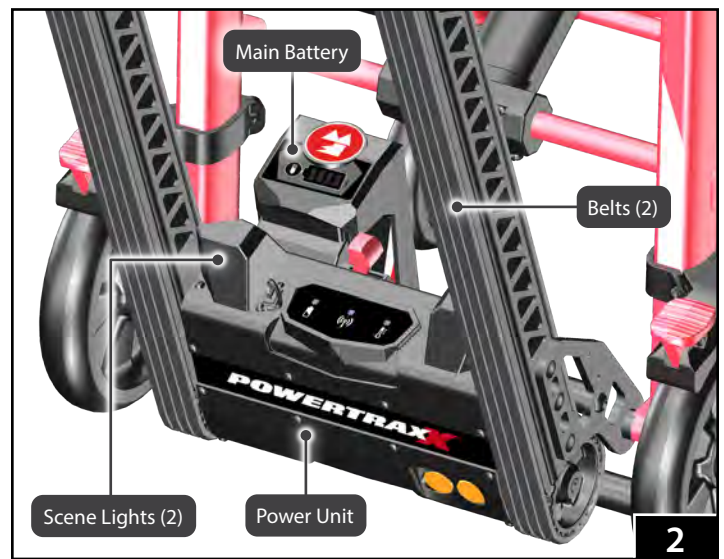
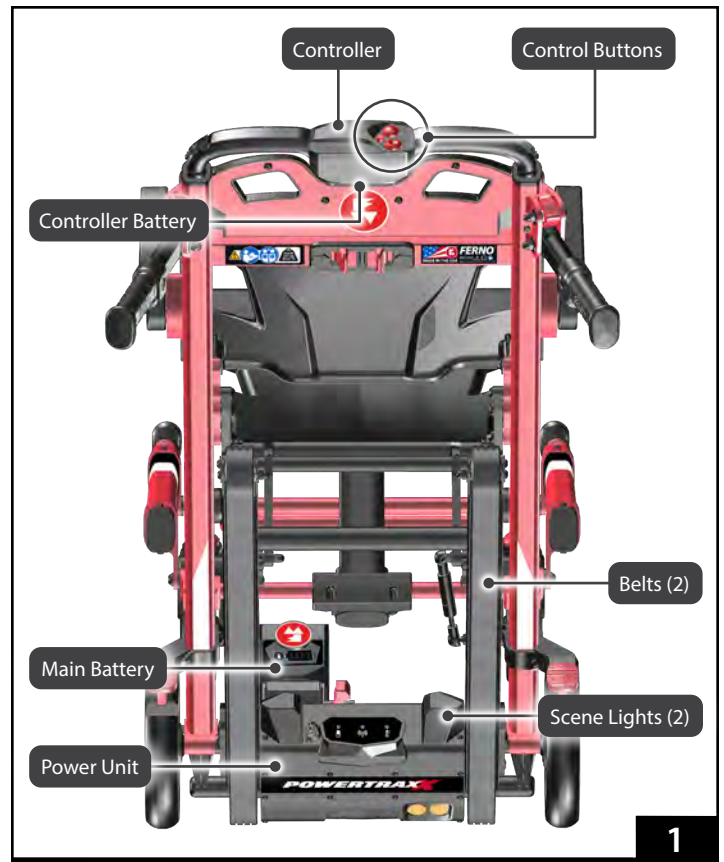

4.2 Main Battery

The term “main battery” is used in this manual to describe the lithium ion battery that powers the PowerTraxx motor and belts. The controller also uses a battery. See “Controller Battery” on page 32.

It is sealed for resistance to precipitation, dirt, body fluids, cleaning solutions, etc. Use only the Ferno-approved battery and battery charger. A battery is provided with purchase of a chair or PowerTraxx retrofit kit. For additional batteries or chargers, see “Accessories” on page 40.

TIP: Lithium-ion batteries have no “battery memory.” You do not need to fully discharge the battery before recharging it.

FERNO 36V ENDURACHARGE™ BATTERY

The PowerTraxx may be configured with a Ferno **ENDURACHARGE™** 36V Li-ion battery (Figure 3) is a rechargeable 36-Volt Direct Current lithium-ion battery. Refer to the battery users’ manual (publication 234-3689) for additional information. To order, see “Parts and Service” on page 38.

Battery Check Button: Press to display the approximate charge of the battery (Figure 3).

Charging: The charge indicator lights illuminate automatically when charging power is applied to indicate the battery is being charged.

Wrench icon: This light indicates faults, damage or other messages when illuminated (Figure 3). If illuminated during normal use, swap for a different battery and inspect the battery. If the problem persists, inspect the chair.

Sleep Mode: After a period of inactivity, the chair will enter Sleep Mode to conserve battery power. Press any button on the chair (↻, ↵, ●) to wake the chair from Sleep Mode.

Battery Storage: Charge the battery before placing it in storage. Store only a fully-charged battery. See “Storing the Battery” on page 35.

MILWAUKEE® 28V BATTERY OPTION

The PowerTraxx may be configured with a Milwaukee® 28-Volt DC, lithium-ion battery. See the Milwaukee battery and battery-charger manuals for additional information.

For warranty claims, take the charger or battery to an authorized Milwaukee Service Center.

Milwaukee products are trademarks of the Milwaukee Electric Tool Corporation, Brookfield, Wisconsin, USA. Milwaukee is a subsidiary of Techtronic Industries Co. Ltd.

WARNING

Improper charging can cause injury or damage. Use only a Ferno-approved battery with the chair, and charge only with a Ferno-approved battery charger.

Modifying the battery can cause injury and damage. Use the battery only as designed by Ferno.

Improper maintenance can cause injury and damage. Maintain the chair and battery only as described in this manual.

NOTICE

Charge the battery immediately upon receipt. Shipping regulations require the battery to be shipped with a 30% charge. Failure to charge the battery in a timely manner can damage the battery.

Charge batteries only with a compatible charger.

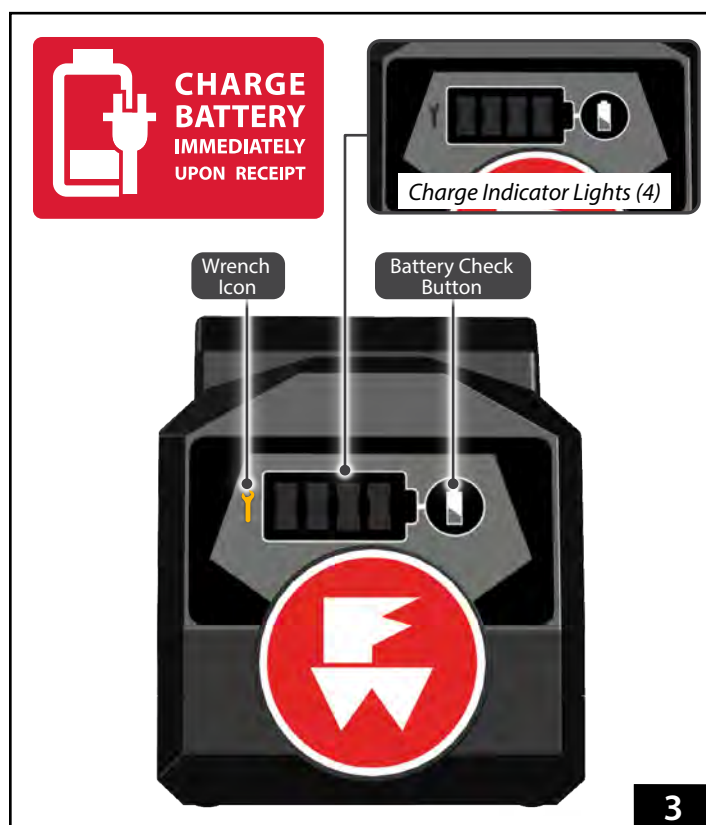

4.3 Attaching and Removing the Main Battery

FERNO 36V ENDURACHARGE BATTERY

To attach the main battery to the chair: Align the mounting slots on the main battery with the mating guides on the power unit. Slide the main battery onto the guides until it snaps into the locked position (Figure 4). Verify that the main battery is securely mounted on the power unit before using the chair.

To remove the main battery from the chair: Slide the red release lever away from the battery (Figure 4) and carefully slide the battery up off the guides on the power unit.



MILWAUKEE® 28V BATTERY

To attach the main battery to the chair: Align the mounting slots on the main battery (Figure 5) with the mating guides on the power unit. Slide the main battery onto the guides until it snaps into the locked position. Verify that the main battery is securely mounted on the power unit before using the chair.



To remove the main battery from the chair: Press both red release buttons on the main battery (Figure 5) and slide it up off the guides on the power unit.



4.4 PowerTraxx Controller

The PowerTraxx controller is mounted to the extending lift bar (Figure 6). It allows the operator to control the direction of the belts, the stair lights and monitor the battery and wireless connection.

CONTROL BUTTONS

-  **ASCEND:** Powers the tracks up stairs
-  **DESCEND:** Powers the tracks down stairs
-  **SCENE LIGHTS:** Provides reflective illumination around the chair. See "Scene Lights" on page 16.

CONTROLLER STATUS LIGHTS

 **WIRELESS CONNECTION:** Displays status of wireless connection between the controller and power unit. The blue status light flashes when wireless connection is established. If the chair loses wireless connection, reconnect using the interconnect cord. See "Interconnect Cord for PowerTraxx" on page 34.

 **CONTROLLER BATTERY:** Displays status of the controller battery. If the battery status light is on, replace the battery. See "Controller Battery" on page 32.

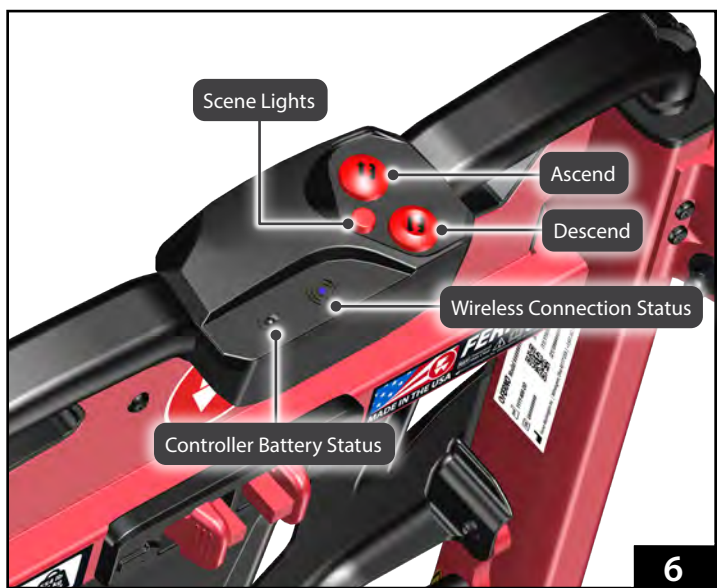

4.5 Scene Lights

The PowerTraxx chair has built-in LED lights to provide reflective illumination around the chair. The ● button on the controller (Figure 7) activates the lights.

The lights have two intensity levels: low and high. Press the ● button to cycle between low, high, and off.

Note: The scene lights turn off when the chair is in sleep mode.



4.6 Sleep Mode

After a period of inactivity, the chair will enter Sleep Mode to conserve battery power. Press any button on the controller to wake the chair from Sleep Mode.

1. Tap a control button (Figure 8) to awaken the wireless controller and allow a few seconds for the wireless connection to be established.

Note: The wireless status light on the controller (Figure 8) is blue when the wireless connection is established. See "Controller Status Lights" on page 15.

2. Use the chair as instructed in this manual.



5 - FEATURES AND OPTIONS

5.1 Track System (Excludes Carry Chair)

The manual track system enables operators to glide the chair down stairs instead of lifting and carrying it. The PowerTraxx is a powered track system that allows the operators to power the chair up and down stairs.

Opening the track system:

1. Grasp the track crosstube (Figure 9) and firmly pull the track system away from the chair until it locks in the open position.
2. Verify that track system has locked by trying to push the tracks closed. If the lock is fully engaged, the track system will not close.

Closing the track system: With your hand, push the track hinge bar down (Figure 10) to fold the track system.

! **WARNING**

Using the chair with an unlocked track system can cause injury. Verify that the track system is locked before transporting the patient.

Lubricating the track system can result in injury to patient and/or operators. Never lubricate the tracks or belts.



5.2 Lift Bar

Use the lift bar to guide and steer the chair when rolling the chair and to control the chair on stairs. On a PowerTraxx chair, the lift bar also contains the control buttons that control the powered track system.

The extending lift bar adjusts to five locked positions (Figure 11). Adjust the height according to operator preference and the task at hand.

1. Unlock the lift bar by squeezing and holding the red lift-bar release tabs together (Figure 12), then raise or lower the lift bar with the other hand.
2. When the lift bar is near the desired position, let go of the release tabs and raise or lower the lift bar until it locks into position.
3. Verify that the lift bar is locked by trying to raise or lower it without squeezing the release tabs. When the lock is engaged the lift bar will not move.

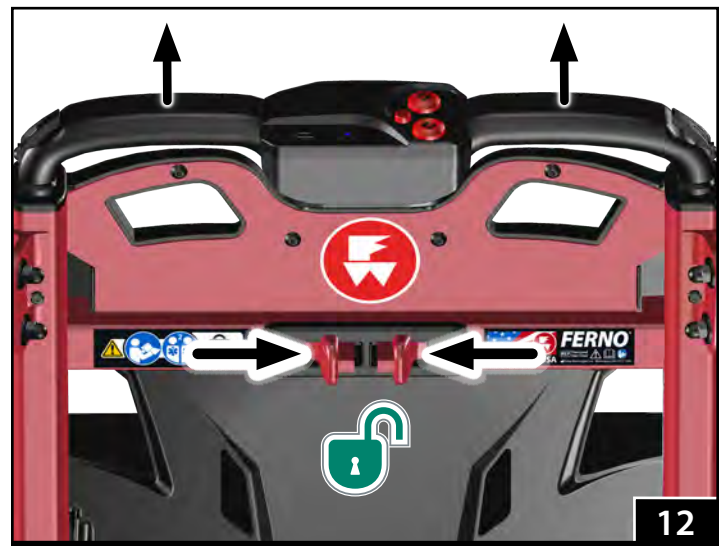

5.3 IV Bag Clip

The lift bar (extending or fixed) has a clip at each corner to attach an IV bag (Figure 13).

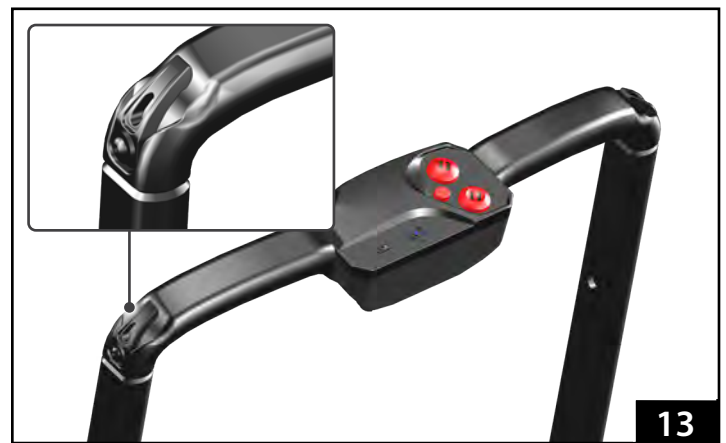

5.4 Rear Lift Handles

Use the rear lift handles to guide and steer the chair when rolling, or to lift and carry the chair over small obstacles.

- To raise a handle, lift the handle until it locks in the raised position.
- To lower a handle, press the red release lever down to disengage the lock (Figure 14), then lower the handle.
- Use both handles together.
- Keep the handles folded when not in use.



5.5 Telescoping Lift Handles

The telescoping lift handles adjust to five locked positions (Figure 15). Adjust the handles according to operator preference and the task at hand.

- Pull the trigger (Figure 15) and push or pull the handle near the desired stopping point. Release the trigger and slide the handle until it locks into position.
- Lock both handles at the same position. Verify that both handles are locked by trying to push or pull them. When the locks are engaged, the handles will not move.



5.6 Armrests

The armrests provide patient security and comfort. The armrests have three positions: down, up, and out. Rotate the armrest to the up or down position.

To unlock the armrest to the out position: Slide the red release button forward and swing the armrest out (Figure 16). The armrest can be returned to the standard down position by pushing inward.

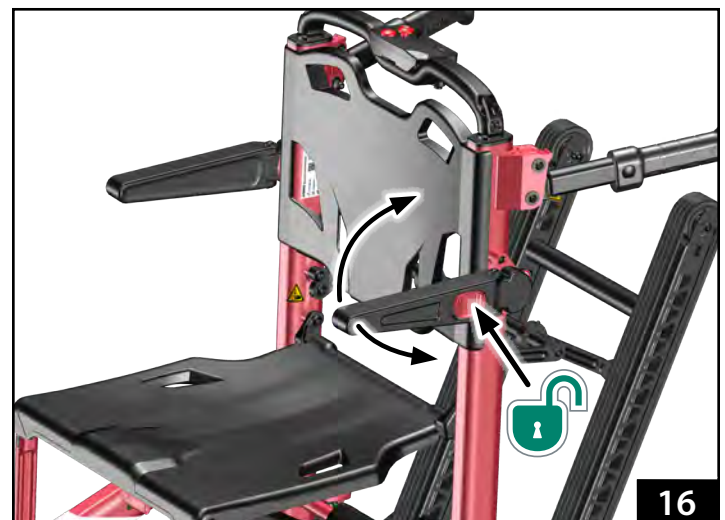

5.7 Footrest

The footrest has two positions: raised for storage (Figure 17), and lowered for use (Figure 18).

To lower the footrest, swing it down until it stops.

To raise the footrest, swing it up until it stops.

Use the footrest properly to ensure that it does not interfere with patient's or operators' feet.

- Before transferring the patient onto the chair, make sure the footrest is raised in the storage position. Seat the patient before lowering the footrest.
- When preparing to transfer the patient off the chair, unfasten the ankle restraint and raise the footrest into the storage position **before** unfastening the patient's torso and lap restraints. This will prevent the patient from attempting to stand before the footrest has been stored out of the way of his/her feet.
- Keep the footrest raised when it is not in use.



5.8 Wheel Locks

The rear wheels are fitted with optional wheel locks (Figure 19) to help keep the chair from rolling during patient transfer.

Stay with the chair and maintain control of it at all times. Do not use the wheel locks as a substitute for operator control.

To lock: Press the lever down (Figure 19).

To unlock: Press the opposite end of the lever (Figure 19).

NOTICE

The wheel locks are not a substitute for operator control. The operators must remain with the chair and keep control of it at all times. Do not leave the patient unattended.

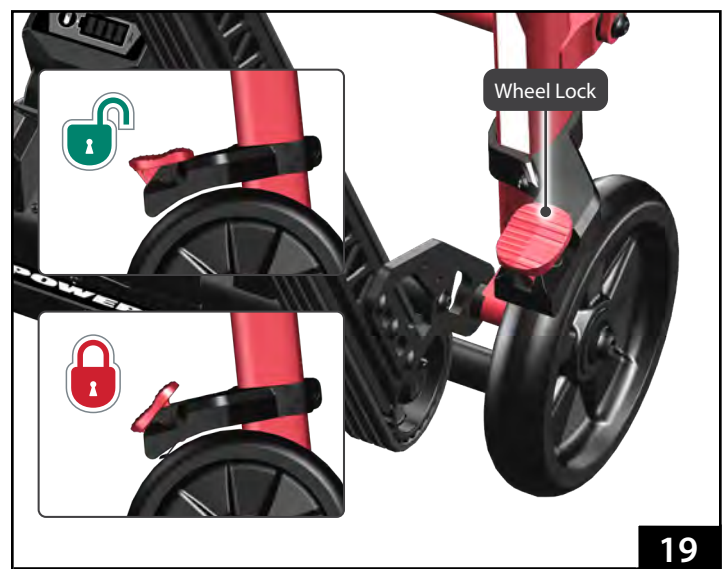

6 - USING THE CHAIR

6.1 Before Placing the Chair in Service

- Before use, personnel who will work with the chair must read and understand this manual. Appropriate skills and training are also required. See “Operator Focus” on page 7.
- Set up the Chair, following the instructions in “Initial Setup” on page 36.
- Confirm that the chair operates properly. See “Inspecting the Chair” on page 31.

6.2 General Guidelines for Use

Medical advice is beyond the parameters of this manual. It is the operators’ responsibility to ensure safe practices for the patient and themselves.

A **minimum** of two trained operators is required.

Operators must:

- Follow standard emergency patient-handling procedures when operating the chair.
- Communicate with one another and use coordinated movements to operate the chair.
- Ferno recommends that a third trained person serve as a “spotter” while using the chair on stairs.
- Lift only the weight you can safely handle. Use additional help when working with heavy loads (patient and equipment). For placement of help, see “Using Additional Help” on page 8.
- Stay with the patient at all times.
- Always use patient restraints to secure the patient on the chair.
- The chair is for use on straight (non-spiral) stairways or inclines.
- If the battery is stored separate from the chair, attach the battery before using the chair.
- Remove any water, ice, snow, or debris from the stairs before using the chair on them.
- Remove any water, ice, snow, or debris from the track and tread belts before using the chair on stairs.
- Verify that the track system is locked in the open position before using the chair on stairs.
- The PowerTraxx chair can be used for manual descent if the power system becomes disabled. See “Using a PowerTraxx Chair Without Power” on page 29.
- PowerTraxx Sleep Mode: After a period of inactivity, the chair will enter Sleep Mode to conserve battery power. Press any button to wake the chair from Sleep Mode.

WARNING

Improper operation can cause injury. Operate the chair only as described in this manual.

An unattended patient can be injured. Stay with the patient at all times.

An unrestrained patient can be injured. Use patient restraints to secure the patient on the chair.

Lubricating the track system can result in injury to patient and/or operators. Never lubricate the track or belts.

NOTICE

The chair is for use on straight stairways or inclines. Use on spiral stairways may cause the track belts to become dislodged.



Load Capacity

Inspect the chair if the load capacity has been exceeded. See “Inspecting the Chair” on page 31.

6.3 Folding and Unfolding the Chair

The red lock release lever below the front edge of the seat (Figure 20) disengages the lock for folding and unfolding the chair. Before seating a patient, verify that the chair is completely unfolded and the lock is engaged.

TIP: The chair lock release lever must be disengaged before you begin folding or unfold the chair. Pull the release lever forward, then fold or unfold the chair.

UNFOLDING THE CHAIR

1. Stand beside the chair and grasp the lift bar with one hand and the lock release lever with the other hand.
2. Pull the release lever forward (Figure 20), then open the chair until it fully unfolds and the lock engages.
3. To verify the lock has engaged, hold the lift bar while pulling up on the chair frame at the front of the seat. The chair will not fold if the lock is engaged.

FOLDING AN OPEN CHAIR

1. Buckle the restraints and arrange the straps to prevent interference with folding the chair.
2. Roll the chair backward to reverse the swivel wheels.
3. Standing at the side of the chair, grasp the lift bar with one hand and the lock release lever with the other hand.
4. Pull the release lever forward, **then** fold the seat toward the back-panel frame.

AS YOU FOLD THE SEAT: Tilt the chair forward to keep the swivel wheels rotated outward (Figure 21). This prevents the wheels from holding the frame away from the seat and allows the lock to engage.

5. Press the seat against the back-panel frame until the lock engages (Figure 21).
6. Verify the lock has engaged by pulling the seat away from the back-panel frame without pulling the lock release lever. The seat will not move if the lock is engaged.

Note: If the swivel wheels prevent the chair from locking in the folded position, hold the chair at a greater tilt to allow the swivel wheels to rotate away from the chair frame.

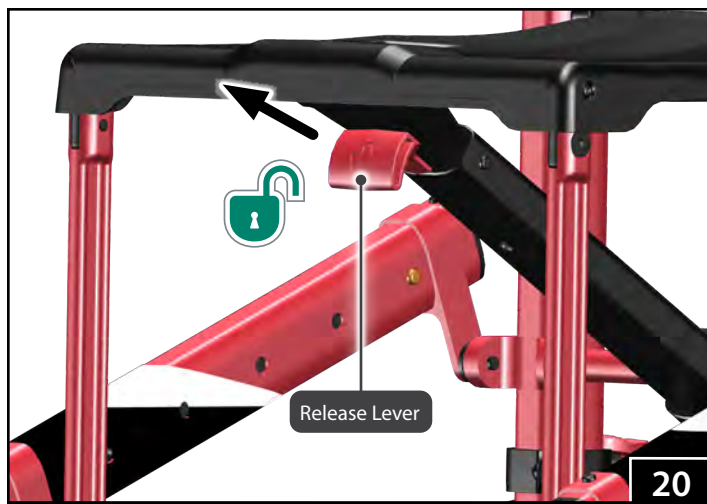

6.4 Transferring the Patient

Always assist the patient onto and off from the chair.

ASSISTING THE PATIENT ONTO THE CHAIR

1. Unfold the chair and verify that it is locked.
2. Engage the wheel locks.
3. Verify that the footrest is in the storage position.
4. Assist the patient onto the chair using accepted practices and following local protocols.
5. Fasten and adjust the torso and lap restraints.
6. Lower the footrest and place the patient's feet on it.
7. Fasten and adjust the ankle restraint.

ASSISTING THE PATIENT OFF FROM THE CHAIR

1. Engage the wheel locks.
2. Unfasten the ankle restraint and raise the footrest to the storage position.
3. Unfasten the torso and lap restraints.
4. Assist the patient off from the chair using accepted practices and following local protocols.



22

6.5 Rolling the Chair

Roll the chair on smooth, flat surfaces whenever possible. For patient comfort, pull the chair backward over low obstacles such as door sills.

Lift and carry the chair over high obstacles and rough terrain or utilize the track system to cross smaller obstacles. When the track system is in use, move the chair only in a straight line. Follow your local protocols and work together to maneuver the chair past the obstacle.

TO ROLL THE CHAIR

1. **Head-End Operator:** Release the wheel locks (if equipped).
2. **Head-End Operator:** Adjust the lift bar to a comfortable height and grasp it to push and guide the chair on all four wheels, or tilt the chair back and roll it on its rear wheels.
3. **Foot-End Operator:** Assist the head-end operator as needed and attend the patient.

6.6 Transporting the Patient Down Stairs

Ferno recommends that the two operators face each other when transporting a patient on stairs and that a third trained person “spot” for the foot-end operator. In some cases, the foot-end operator may be able to descend the stairs facing forward, with his back to the patient. Follow your local protocols for using chairs.

Ferno recommends you visualize a “landing zone” at the top or bottom of the stairway. The landing zone should provide enough clear, safe space for the chair to be set on all four wheels, away from the edge of the stairway. In a narrow stairway, you may need to retract the handles between each flight of stairs.

If the operators tire or need to attend the patient while on stairs, see “Pausing On the Stairs” on page 29.

USING THE CARRY CHAIR TO DESCEND STAIRS

1. **Head-End Operator:** Roll the chair to the stairs and engage the wheel locks (if equipped).
2. **Foot-End Operator:** Extend the foot-end lift handles to the desired stop point. Verify that both handles are locked and maintain your grasp.
3. **Spotter:** Stand below the foot-end operator with a hand on the operator’s back to help steady and guide him/her throughout the descent.
4. **Head-End Operator:** Raise the lift bar to the desired position and verify that it is locked. Or, use the rear lift handles, if your chair has rear lift handles.
5. **Head-End Operator:** Disengage the wheel locks and tilt the chair back.
6. **Operators and Spotter:** Operators work together to lift the chair and carry it down the stairs. The spotter keeps a hand on the foot-end operator’s back and provides verbal guidance.
7. **Operators:** At the bottom of the stairs, the operators set the chair on the floor and retract the lift handles.
8. **Head-End Operator:** Adjust the lift bar to a comfortable height before rolling the chair.

WARNING

Track Chair Models: Using the chair with an unlocked track system can cause injury. Verify that the track system is locked before transporting the patient.

NOTICE



When the track system is in use, move the chair only in a straight line. Do not twist or turn the chair while using the track system as the belts may become dislodged from the track. Set the chair on its wheels between stairways, to turn corners, or to change direction.

USING THE MANUAL TRACK CHAIR TO DESCEND STAIRS

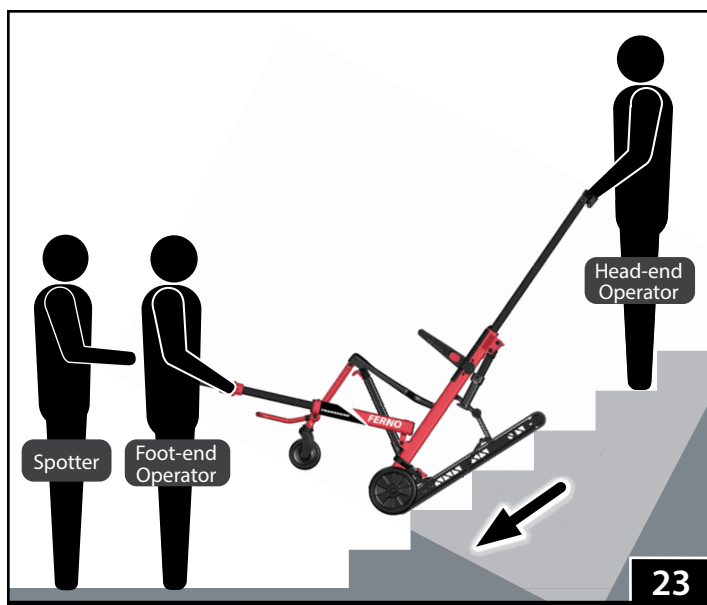
1. **Head-end Operator:** Roll the chair near the stairs and engage the wheel locks (if equipped).
2. **Head-end Operator:** Open the track system (See "Track System" on page 17). Verify that it has locked.
3. **Head-End Operator:** Raise the lift bar to the desired position and verify that it is locked.
4. **Foot-end Operator:** Extend the foot-end lift handles to the desired positions and verify that all handles are locked.
5. **Spotter:** Stand below the foot-end operator with a hand on the operator's back to help steady and guide him/her throughout the descent (Figure 23).
6. **Head-end Operator:** Disengage the wheel locks.
7. **Both Operators:** Together, tilt the chair back until the belts engage the floor.
8. **Both Operators:** Working together, guide the chair slowly forward and downward until the tracks engage two or three steps. This establishes the glide angle.
9. **Both Operators:** To maintain the glide angle as you descend, work together and:
 - o **Head-end Operator:** Apply slight downward pressure on the extended lift bar.
 - o **Foot-end Operator:** Apply slight upward pressure on the foot-end lift handles.
10. **Both Operators:** At the bottom of the stairway, tilt the chair onto all four wheels.
11. If the chair has reached the destination, prepare the chair for rolling by retracting the foot-end lift handles, rear lift handles, and/or lowering the lift bar to a comfortable height. Close the track system.
12. To continue the descent, adjust the lift handles and lift bar as needed to maneuver the chair to the next stairway.



USING THE POWERTRAXX TO DESCEND STAIRS

1. **Head-end Operator:** Roll the chair near the stairs and engage the wheel locks.
2. **Head-end Operator:** Open the track system (See "Track System" on page 17). Verify that it has locked.
3. **Both Operators:** Raise the lift bar and/or extend the foot-end lift handles to the desired positions and verify that all handles are locked.
4. **Spotter:** Stand below the foot-end operator with a hand on the operator's back to help steady and guide him/her throughout the descent (Figure 24).
5. **Head-end Operator:** Disengage the wheel locks.
6. **Both Operators:** Together, tilt the chair back until the belts engage the floor.
7. **Head-End Operator:** Press  control button to start the power system in the proper direction to descend the stairs (Figure 24).
8. **Both Operators:** Together, and using the chair power, move the chair slowly forward and downward until the tracks engage two or three steps. This establishes the glide angle.
9. **Both Operators:** Move in a straight line and at a steady pace down the stairs, allowing the motor to do the work. To maintain the glide angle as you descend, work together and:
 - o **Head-end Operator:** Apply slight downward pressure on the extended lift bar.
 - o **Foot-end Operator:** Apply slight upward pressure on the foot-end lift handles.
10. **Both Operators:** Continue moving the chair in a straight line to the bottom of the stairway, then tilt the chair onto its wheels as the Head-end Operator stops pressing the  control button.
11. If the chair has reached the destination, or if needed to maneuver the chair to the next stairway:
 - o **Foot-end Operator:** Retract the foot-end lift handles.
 - o **Head-End Operator:** Close the track system. Adjust the lift bar to a comfortable height.
 - o **Both Operators:** Roll the chair.
12. To continue the descent, reposition the chair to continue the descent. Use the chair wheels to turn and position the chair for the next stairway.

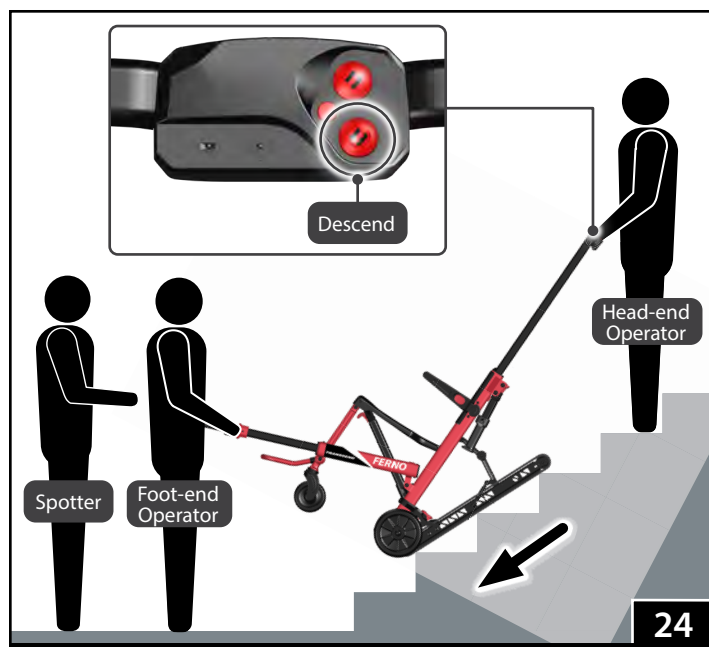

6.7 Transporting the Patient Up Stairs

Ferno recommends that the two operators face each other when transporting a patient on stairs and that a third trained person “spot” for the foot-end operator. In some cases, the foot-end operator may be able to descend the stairs facing forward, with his back to the patient. Follow your local protocols for using chairs.

Ferno recommends you visualize a “landing zone” at the top or bottom of the stairway. The landing zone should provide enough clear, safe space for the chair to be set on all four wheels, away from the edge of the stairway. In a narrow stairway, you may need to retract the handles between each flight of stairs.

If the operators tire or need to attend the patient while on stairs, see “Pausing On the Stairs” on page 29.

USING THE CARRY CHAIR OR MANUAL TRACK CHAIR TO ASCEND STAIRS

If the chair is equipped with optional rear lift handles, the head-end operator may grasp those handles instead of the lift bar.

1. **Both Operators:** Roll the chair to the bottom of the stairs and position it with the patient’s back to the stairs.
2. **Head-End Operator:** Raise the lift bar to the desired position and verify that it is locked. Or, use the rear lift handles, if your chair has rear lift handles.
3. **Head-End Operator:** If the chair has a manual track system, do not open the track system.
4. **Spotter:** Stand above the head-end operator with a hand on the operator’s back to help steady and guide him/her throughout the ascent.
5. **Foot-End Operator:** Extend the foot-end lift handles to the desired position and verify that both handles are locked.
6. **Both Operators and Spotter:** Working together, the operators grasp the lift bar and lift handles and carry the chair up the stairs. The spotter keeps a hand on the head-end operator’s back and provides verbal guidance.
7. **Both Operators:** At the top of the stairs, the head-end operator sets the rear wheels of the chair on the floor and rolls the chair backward until the front wheels are securely on the floor.
8. If the chair has reached the destination, prepare the chair for rolling by retracting all handles and/or lowering the lift bar to a comfortable height.
9. To continue the ascent, adjust the lift handles and lift bar as needed to maneuver the chair to the next stairway.



WARNING

Track Chair Models: Using the chair with an unlocked track system can cause injury. Verify that the track system is locked before transporting the patient.

NOTICE

When the track system is in use, move the chair only in a straight line. Do not twist or turn the chair while using the track system as the belts may become dislodged from the track. Set the chair on its wheels between stairways, to turn corners, or to change direction.

USING THE POWERTRAXX TO ASCEND STAIRS

1. **Both Operators:** Roll the chair backward near the bottom of the stairs and engage the wheel locks.
 - Open the track system and verify that it has locked.
 - Operators raise the lift bar and/or extend the foot-end lift handles to the desired positions and verify that all handles are locked.
2. **Spotter:** Stand above the head-end operator with a hand on the operator's back to help steady and guide him/her throughout the ascent (Figure 25).
3. **Head-end Operator:** Disengage the wheel locks.
4. **Both Operators:** Together, tilt the chair back until the top of the track belts touch the edge of the lowest step of the stairway.
5. **Head-End Operator:** Press the  control button to start the belts moving in the proper direction to ascend the stairs (Figure 25).
6. **Both Operators:** Together, and using the chair power, allow the chair to climb the stairway. The tracks should engage two or three steps. This establishes the glide angle.
7. **Both Operators:** Move in a straight line and at a steady pace up the stairs, allowing the chair motor to do the work. To maintain the glide angle as you ascend, work together and:
 - **Head-end Operator:** Apply slight downward pressure on the extended lift bar.
 - **Foot-end Operator:** Apply slight upward pressure on the foot-end lift handles.
8. **Both Operators:** Continue moving the chair in a straight line onto the landing at the top of the stairs, then tilt the chair onto its wheels as the Head-end Operator stops pressing the  control button.
9. If the chair has reached the destination, prepare the chair for rolling by retracting the lift handles and lowering the lift bar to a comfortable height.
10. To continue the ascent, adjust the lift handles and lift bar as needed to maneuver the chair to the next stairway.

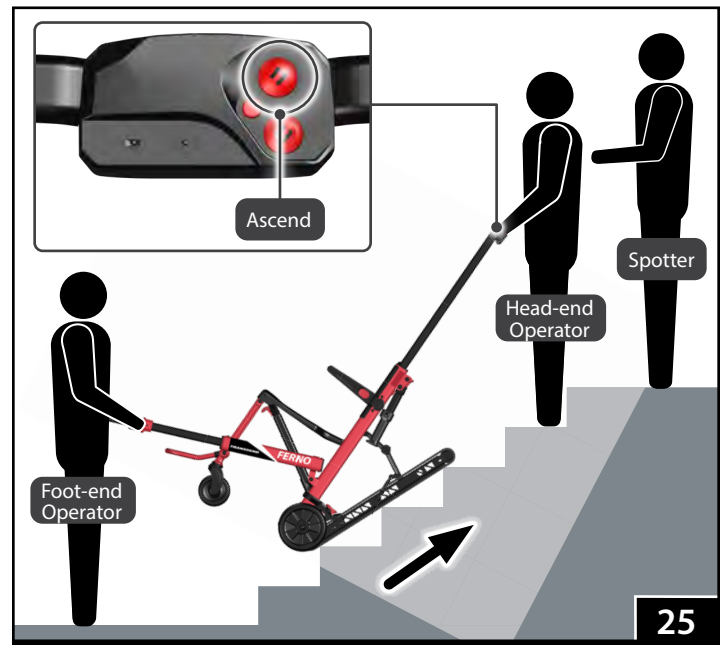

6.8 Pausing On the Stairs

If the operators tire, or need to attend the patient during a transport up or down stairs, the operators communicate and work together to pause on the stairs.

CARRY CHAIR AND MANUAL TRACK CHAIR

To Stop: Tilt the chair forward just enough to allow the rear wheels to rest on the step while both operators hold the chair in place (Figure 26).

To Resume:

- **Carry Chair:** Lift and carry the chair as instructed in this manual.
- **Manual Track Chair:** Tilt the chair back to the glide angle and engage the belts on the steps. Continue down the stairs as instructed in "Transporting the Patient Down Stairs" on page 24.

POWERTRAXX CHAIR

To Stop: Stop pressing the control button. Tilt the chair forward just enough to allow the rear wheels to rest on the step while both operators hold the chair in place (Figure 26).

Note: *If the system has power, the track brake engages automatically when the control buttons are not activated.*

To Resume: Tilt the chair back to the glide angle and engage the belts on the steps. Press the appropriate control button to resume the ascent or descent.

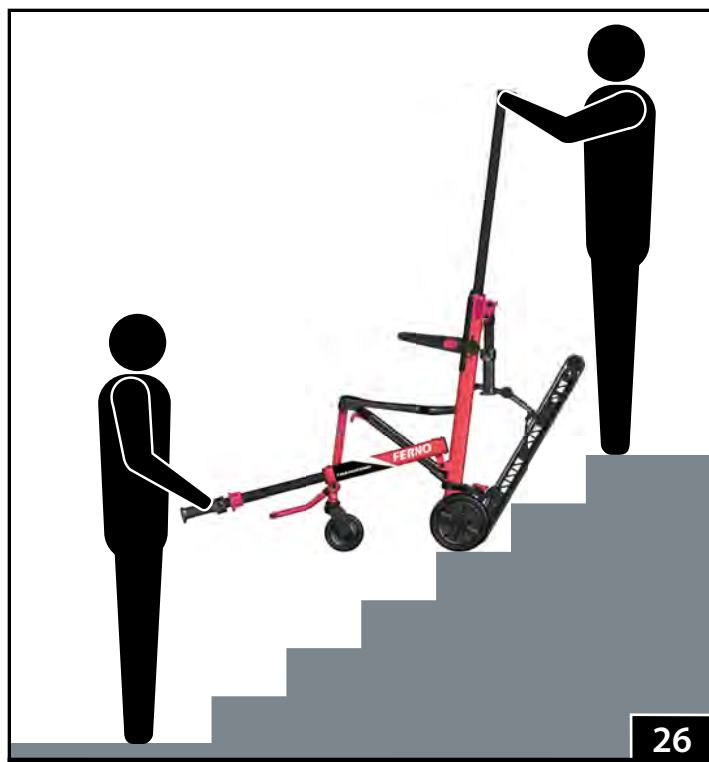

6.9 Using a PowerTraxx Chair Without Power

DESCENDING STAIRS WITHOUT POWER

If the PowerTraxx system loses power, the belts are free to rotate, however, the internal speed limiter will limit the speed of the belts as the chair descends the stairs. Use care and control the descent of an unpowered chair.

Follow the instructions in "Using the Manual Track Chair to Descend Stairs" on page 25, and allow the tracks to carry the weight of the chair and patient.

ASCENDING STAIRS WITHOUT POWER

If the PowerTraxx system fails for any reason during an ascent, the operators must pick up the chair with its patient and carry them up the stairs. See "Using the Carry Chair and Manual Track Chair to Ascend Stairs" on page 27.

7 - MAINTENANCE

7.1 Maintenance Schedule

The chair requires regular maintenance. Set up and follow a maintenance schedule. The table at right represents minimum intervals for maintenance.

Keep maintenance records. A sample maintenance record sheet is provided on page 42.

When using maintenance products, follow the manufacturers' directions and read the manufacturers' material safety data sheets.

7.2 Disinfecting/Cleaning Restraints

Ankle Restraint: Place buckled restraint in a mesh bag and launder in a washing machine using warm water, a disinfectant soap, and gentle agitation. Hang the restraint to dry. Do not put it in a dryer.

Chest and Lap Restraints: Disinfect and clean restraints as directed in the restraint users' manual provided. Additional, free users' manuals can be obtained from Ferno Customer Relations (page 2).

7.3 Disinfecting/Cleaning the Chair

To disinfect: Remove restraints and wipe all surfaces of the chair and panels with disinfectant. Follow the disinfectant manufacturer's directions for application method and contact time.

To clean: Wash panels and all parts of the chair with warm water and a mild detergent. Rinse with clean water. Dry with a towel or allow to air-dry.

7.4 Cleaning Tracks and Belts

To ensure predictable belt performance, it is important to keep the track and belts free of oil, grease, dirt, and debris.

1. Hold the belts away from the track frame and remove any debris.
2. Clean both sides of the track frame, and both belts, with SD-20™ All-Purpose Cleaner and a clean cloth. Follow instructions on the container.
3. Dry track and belts thoroughly.

To order SD-20™ Cleaner in North America, contact the Spartan Chemical Company, Maumee, Ohio, USA at 1.800.537.8990 or visit www.spartanchemical.com on the internet.

7.5 Lubrication-Free Chair and Tracks

The chair and tracks are constructed with lubrication-free materials. **Never lubricate the track, the PowerTraxx, or any other part of the track system or chair.** Applying lubricant can cause damage to the chair. Lubricants on the belts or track can cause the chair to perform unpredictably, resulting in injury to the patient and/or operators.

⚠ WARNING

Improper maintenance can cause injury. Maintain the chair only as described in this manual.

Lubricating the track system can result in injury to patient and/or operators. Never lubricate the tracks or belts.

Minimum Maintenance	Each Use	As Needed	Monthly
Disinfecting (this page)	•		
Cleaning (this page)		•	
Inspection (page 32)		•	•

NOTICE

Disinfectants and cleaners containing bleach, phenolics, or iodines can cause damage. Use caution when disinfecting and cleaning with products containing these chemicals.

Using abrasive cleaning compounds or applicators on the chair can cause damage. Do not use abrasive materials to clean the chair or PowerTraxx.



DO NOT PRESSURE WASH

Water under high pressure, or steam, can penetrate joints, flush away lubricant, and cause corrosion. Do not pressure wash the chair or PowerTraxx.



Do Not Lubricate

7.6 Inspecting the Chair

Have your service's equipment maintenance personnel inspect the chair at regular intervals. Conduct a visual inspection of the track system before use, and a thorough inspection of the track system as needed.

Follow the checklists on this page and work the chair through all its functions as described in this manual.

If inspection shows damage or excessive wear, remove the chair from service until repairs are made. See "Parts and Service" on page 38.

Inspection Checklist

- Are all components present?
- Is the chair free of excessive wear?
- Are all screws, nuts, bolts, rivets, and roll pins securely in place?
- Do all moving parts operate smoothly and properly?
- Do all locks on the chair operate properly?
- Does the chair roll smoothly?
- Are the restraints properly installed?
- Is restraint webbing in good condition with no cuts or frayed edges?
- Are restraint buckles free of visible damage and do they operate properly?
- Do installed accessories operate properly without interfering with chair operation?

POWERTRAXX INSPECTION

- Do the control buttons function properly?
- Is there visible sign of damage to the motor, controller, batteries, or battery charger?
- Does the main battery attach properly to the motor?
- Do the charge indicators on the battery and on the controller function properly?
- Is the battery-charger power cord free of excessive wear, cuts, and fraying?

TRACK SYSTEM INSPECTION

- Are the tracks and belts free of lubricant, dirt and debris?
- Is there visible damage to the track or belts?
- Do the belts operate properly through the full range of motion, without becoming loose or off-track?
- Does the track system operate smoothly, without binding or excessive noise?
- Are the inner cords of the belts visible (indicating the need for replacement)?
- Are the belt-tensioning bolts and nuts tight?

7.7 Controller Battery

One CR123A lithium-ion battery powers the controller. If the low-battery icon  light is on, replace the battery.

Also, if there are no lights on the controller and the control buttons stop functioning, replace the CR123A battery.

Access the battery by removing the access door on the reverse side of the controller (Figure 27).

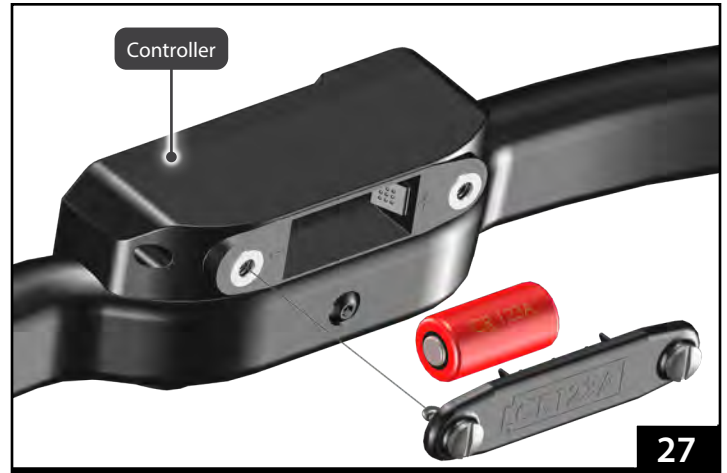

7.8 PowerTraxx Motor Status Lights

There are three LED lights on top of the PowerTraxx motor housing (Figure 28) to indicate the status of the main battery, wireless connection and motor temperature.

 **MAIN BATTERY:** Displays the status of the main battery. If the battery status light is on, the battery is discharged and should be replaced. See “Attaching and Removing the Main Battery” on page 15.

 **WIRELESS CONNECTION:** Displays status of wireless connection between the controller and motor. Status light is blue when you tap a control button and the wireless connection is established. If the chair loses wireless connection, the status light will turn red. Reconnect using the interconnect cord. See “Interconnect Cord for PowerTraxx” on page 34.

 **CHECK TEMPERATURE:** Displays the status of the PowerTraxx motor temperature. If the light is on and amber in color, the motor is above normal temperature range. If possible, discontinue powered use of the chair until the motor has cooled and the check temperature light is off. If the light is red in color, the motor will temporarily shut down until the motor has cooled.

If all three LED lights on the motor are red and blinking, the PowerTraxx system has failed. Contact EMSAR (in the U.S.A. or Canada) or your Ferno distributor for parts and service. See “Parts and Service” on page 38.

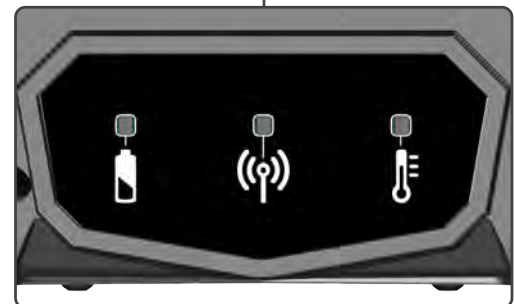
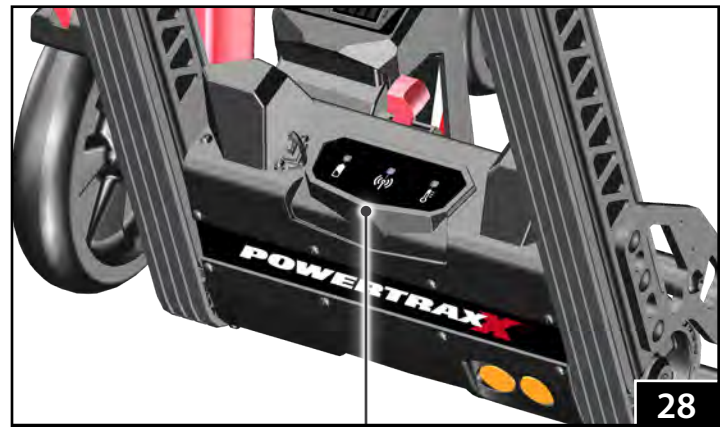

7.9 Removing and Attaching the Backrest and Seat Panels

BACKREST PANEL

To remove the backrest panel: Use a 3 mm hex wrench to remove the six screws attaching the panel to the chair frame (Figure 29). Pull the panel away from the chair.

To attach the backrest panel: Place the panel on the backrest chair frame with all mounting holes aligned. Use a 3 mm hex wrench to install the four M5 x 8 screws to the top of the panel and two M5 x 10 screws to the bottom of the panel attaching the backrest to the chair (Figure 29).

SEAT PANEL

To remove the seat panel: Use a 3 mm hex wrench to remove the four screws attaching the panel to the chair frame (Figure 30). Pull the panel away from the chair.

To attach the seat panel: Orient and press the panel to the chair frame with all mounting holes aligned. Use a 3 mm hex wrench to install the four screws attaching the panel to the chair (Figure 30).



7.10 Interconnect Cord for PowerTraxx

The USB interconnect cord physically connects the controller with the motor. It serves two purposes:

- (Optional) The interconnect cord can be connected permanently to bypass the wireless system. If you decide to use the interconnect cord permanently, arrange the cord so it will not be pinched by opening, closing, or using the chair.

Note: *The interconnect cord does not disable the wireless system when it is connected.*

- The interconnect cord can re-establish the wireless link between the controller and motor. The controller and motor are linked during assembly and should not lose contact during normal use. If the connection is lost, do the following to re-link the components:
 1. Plug in the USB-C end of the cord to the port on the controller (Figure 31).
 2. Remove the cover and plug the USB-A end the cord into the port on the motor (Figure 31).
 3. The wireless connection light (📶) will flash blue (Figure 31) when the cord is connected and will then turn green after the controller and motor are paired.
 4. Disconnect the interconnect cord and insert the cover into the USB-A port.



7.11 Storing the Main Battery

The battery's storage mode feature protects it from damage if it will not be used for a period of time. See the battery users' manual, publication 234-3689, for complete information.

FERNO ENDURACHARGE BATTERY

- Charge the battery fully before storing it. Do not store the battery with less than a full charge.
- Maximum storage duration: 18 months.
- After a period of storage, charge the battery fully before use.
- Store the battery only indoors in a cool, dry place.
 - Storage Temperature Range: -40°C to 60°C; -40°F to 140°F.
 - Do not store batteries outdoors, or where temperatures will exceed the Battery Storage Temperature range.
 - Battery capacity can be affected if the battery is stored for long periods outside of the recommended temperature range.

To store a battery:

1. Fully charge the battery.
2. Press the battery check button for 30 seconds (Figure 32). After 20 seconds, the wrench will flash the final 10 seconds.

To activate the battery after storage, press the battery check button to wake it up. Then charge the battery.

MILWAUKEE BATTERY

See the Milwaukee battery and battery-charger manuals for additional information.

Milwaukee products are trademarks of the Milwaukee Electric Tool Corporation, Brookfield, Wisconsin, USA. Milwaukee is a subsidiary of Techtronic Industries Co. Ltd.

7.12 Recycling Notice

Batteries: Recycle batteries when they can no longer hold a charge. Do not dispose of batteries with municipal waste. Contact the government in your state, territory or country for proper recycling.

Charger: Recycle the charger if it becomes damaged or fails to properly charge the battery. Do not dispose of the charger with municipal waste. Contact your government for proper recycling.

WEEE DIRECTIVE (EUROPEAN UNION)

European Union directive 2002/96/EC Waste Electrical and Electronic Equipment (WEEE) limits the disposal of electrical and electronic equipment in landfills. Contact the government in the country in which you reside for recycling information.

U.S.A. AND CANADA

Ferno is a partner with Call2Recycle Inc., a nonprofit corporation dedicated to helping consumers locate places to responsibly dispose of rechargeable batteries to meet all U.S. and Canadian requirements. The *ENDURCharge* battery is licensed with Call2Recycle. Contact **Call2Recycle** toll-free for a nearby location to send or drop off rechargeable batteries.

Call2Recycle does not accept the charger. Contact your local EPA to dispose of a damaged or nonfunctional charger.



NOTICE

Before placing the battery in storage, charge the battery. Store only a fully-charged battery.

If the battery is deeply discharged, the ICS may not be able to charge the battery. Connect the battery directly to the charger separate from the ambulance and ICS.

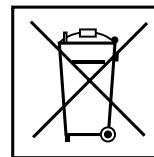

WEEE Directive

Do not dispose of batteries in municipal waste



ENDURCharge 36 VDC

Lithium-iron phosphate battery (LiFePO4)

TO CONTACT CALL2RECYCLE:

1.800.822.8837

<http://www.call2recycle.org/>





<http://www.call2recycle.ca/>

8 - INITIAL SETUP

8.1 First-Time Setup

- Attach the restraints as described in this section.
- Inspect the chair (see “Inspecting the Chair” on page 31).

For PowerTraxx:

- Charge the battery immediately upon receipt until it has a full charge. To comply with shipping regulations, the battery must be shipped with less than a 30% charge. Charge the main battery using only a Ferno-approved battery charger (supplied). Refer to the battery users’ manual (publication 234-3689) for complete information.
- Attach the fully-charged main battery to the chair. See “Attaching and Removing the Main Battery” on page 15.
- Install the CR123A lithium-ion battery (supplied) in the controller (see “Controller Battery” on page 32).
- Verify the PowerTraxx functions properly. If the tension needs to be adjusted, see “Adjusting the Belt Tension” on page 9.
- Verify the   buttons power the belts in both directions.
- If all batteries are properly charged and installed but the   buttons do not function, the wireless connection may have been lost. See “Interconnect Cord for PowerTraxx” on page 34.

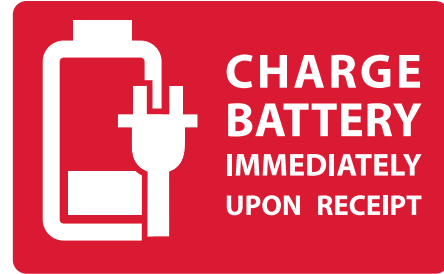

8.2 Ankle Restraint

If your chair has a footrest, the ankle restraint helps keep the patient’s feet secured on the footrest. Attach the two-piece ankle restraint to the front legs of the chair (Figure 33). To attach the restraint:

1. Unbuckle the restraint to separate the straps.
2. Wrap a strap around one front leg of the chair and thread the buckle through the loop, then pull the strap tight around the chair leg.
3. Attach the remaining strap to the opposite front leg.
4. Buckle the restraint and adjust the length.



8.3 Attaching Patient Restraints

Use patient restraints to help hold the patient on the chair. Each restraint must capture **both** the aluminum chair frame and the seat or back panel (Figure 34). Follow local protocols when attaching restraints.

USING TWO-PIECE RESTRAINTS

1. Feed the loop of a restraint strap through a slot in the seat or back panel.
2. Wrap the strap around the aluminum chair frame and feed the male or female buckle through the loop, then pull the strap tight against the frame and panel.
3. Repeat Steps 1-2 for the other half of the restraint.

USING ONE-PIECE RESTRAINTS

Note: *Two-piece restraints are recommended.*

1. To attach the seat-panel restraint, lay the restraint across the top of the seat panel and feed the male and female ends of the restraint down through the slots.
2. Wrap the restraint around the aluminum chair frame on each side of the chair, capturing both the panel **and** the frame.
3. Buckle the restraint and adjust the length.
4. Repeat Steps 1-3 to attach the back-panel restraint.

NOTICE

Restraint rules (also follow your local protocols):

- Use a minimum of two restraints.
- One restraint must be secured across the chair seat to help hold the patient on the chair.
- Each restraint or strap must capture the aluminum chair frame and the plastic panel.



8.4 Restraint Configurations

Follow local protocols when configuring and using restraints. Two possible configurations are described below.

HORIZONTAL CONFIGURATION

Use one restraint for the chest and one restraint for the lap (Figure 35). Use additional restraints as needed.

1. Attach the chest straps through the vertical slots in the back panel.
2. Attach the lap straps through the seat panel slots.

CRISS-CROSS CONFIGURATION

Use two restraints for the torso and a third restraint for the lap (Figure 35).

1. Attach one strap of a restraint through a horizontal slot on the back panel of the chair.
2. Attach the mating strap of the same restraint through the seat panel slot on the opposite side of the chair.
3. Repeat with the second restraint, attaching its straps to opposite sides of the chair.
4. Attach the lap restraint through the seat-panel slots.



9 - PARTS AND SERVICE

9.1 U.S.A. and Canada

In the United States and Canada, contact EMSAR, the only organization authorized by Ferno to manage, service, and repair Ferno chairs.



Telephone (Toll-free)	1.800.73.EMSAR
Telephone (Worldwide)	1.937.383.1052
Fax (Worldwide)	1.937.383.1051
Internet	www.EMSAR.com

WARNING

Improper parts and service can cause injury. Use only Ferno parts and Ferno-approved service on the chair.

Modifying the chair can cause injury and damage. Use the chair only as designed by Ferno.

9.2 Worldwide

To order Ferno parts, and for professional repair, contact your Ferno distributor. Your distributor is the only agent authorized by Ferno to manage, service, and repair Ferno chairs.

9.3 Parts List

No.	Part	Description	Qty
1	090-6099	Controller	1
2	090-0024	Belt for Manual Track	1
3	090-9994	Seat Panel	1
4	090-9998	Backrest Panel	1
5	090-0023	Controller Battery Cover	1
6	090-0012	Rear Lift Handle	1
7	090-6100	Wheel Lock, Rear	2
8	090-6098	Wheel, Front with Caster	1
9	090-6097	Telescoping Lift Handle End Cap	1
NS	090-9993	Glide Bar	1
NS	090-0013	Labels (set)	1

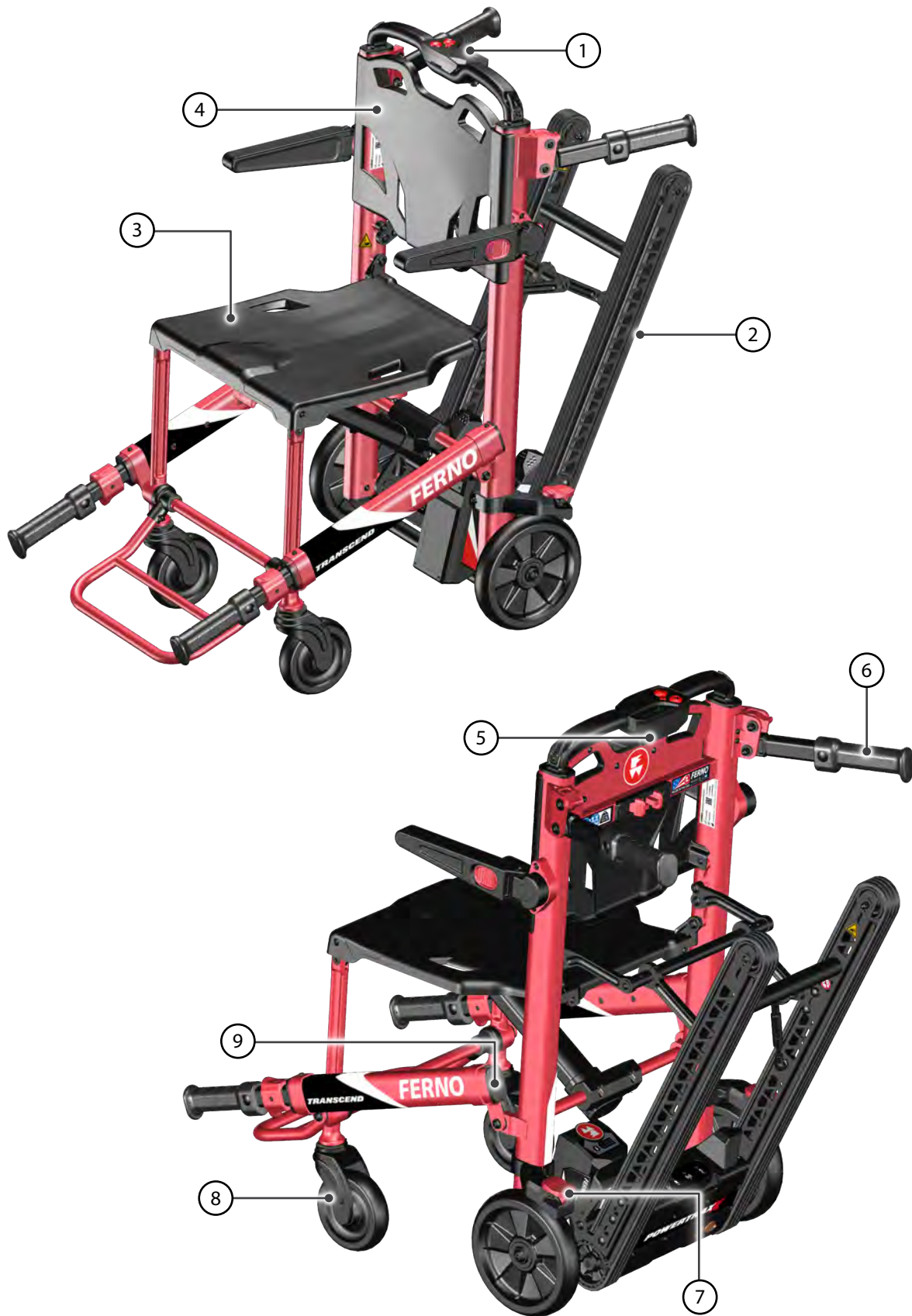

10 - ACCESSORIES

Ferno offers a full line of accessories approved for use with the chair. Follow all instructions in accessory users' manuals. Keep the instructions with this manual.

When using accessories, be aware of any special considerations such as doorway heights and widths, or other factors which may be affected by the addition of the accessory/accessories to the chair.

Contact Ferno Customer Relations (page 2) or your Ferno distributor for more information.

TRANSCEND CHAIR ACCESSORIES

Description	Part Number
Oxygen Cylinder Holder	082-2053
IV Bag Clip	082-2022
Headrest	082-2023
Locking Rear Lift Handles (Pair)	082-2028
Armrest (Pair)	082-2052
Manual Track Conversion Kit	082-2054
Lift Bar, Fixed	082-2142
Lift Bar, Telescoping	082-2143

RESTRAINTS

Description	Part #
Restraint Set	082-2024
Ankle Restraint	082-1973
430-P Restraint 2-piece, 5' (1.5 m), black, plastic buckle	031-3797
430-P Restraint, 2-piece, 7' (2.1 m), black, plastic buckle	031-3801
430 Restraint, 2-piece, 5' (1.5 m), black, metal buckle	031-3892
430 Restraint 2-piece, 7' (2.1 m), black, metal buckle	031-3911

WALL MOUNTS

Description	Part #
Wall Bracket (Hooks Secures Top of Chair Only)	082-2096
Wall Mount Cabinet	050-6534
Storage Cover	031-4023

WARNING

**Attaching improper items to the chair can cause injury.
Use only Ferno-approved items on the chair.**

PowerTraxx Accessories	Kit
PowerTraxx Conversion Kit (see Note)	082-2141
ENDURACharge Battery, single	082-2484
AC Wall-Mount Charger (US)	082-2509
AC Wall-Mount Charger (Europe)	082-2520
AC Wall-Mount Charger (UK)	082-2521
AC Wall-Mount Charger (Australia)	082-2522
AC Input Cord Only, USA	160-0668
AC Input Cord Only, United Kingdom	218-3084
AC Input Cord Only, Europe	218-3085
AC Input Cord Only, Australia	218-3086
28 VDC Milwaukee Battery	083-2198
Milwaukee Charger, 120 VAC	083-2199
Milwaukee Charger, 240 VAC	083-2200
USB Interconnect Cord (Type A to C)	082-2029
USB Interconnect Cord Storage Bag	283-1649
Battery Conversion Kit, 36V	082-2515
Battery Conversion Kit, M28	082-2516

Note: PowerTraxx conversion kit contains one battery, one charger, and the PowerTraxx unit.

TRAINING RECORD

Date	Printed Name	Signature	Training Method			Trainer Initials
			Read Manual	Video/ Online	Hands-On	

MAINTENANCE RECORD

Date	Maintenance Performed	By



NOTES



70 Weil Way
Wilmington, OH 45177

Aviation

Military

Mortuary

EMS

Rescue
